

PLEASE CHECK WWW.MOLEX.COM FOR LATEST PART INFORMATION

Part Number: **0340620002**
Status: **Active**
Overview: mx150 sealed connector system
Description: 5.00mm (.197") Pitch MX150™ Cable Sealed Female Connector, Single Row, 2 Circuits, Polarization B, without Connector Position Assurance, Gray

Documents:

| | |
|---|--|
| 3D Model | Product Specification PS-34062-000 (PDF) |
| Application Specification (PDF) | RoHS Certificate of Compliance (PDF) |
| Drawing (PDF) | |

General

| | |
|--------------------------------|---|
| Product Family | Crimp Housings |
| Series | <u>34062</u> |
| Comments | No Connector Position Assurance (CPA) |
| More Detailed Tech Information | http://ewcap.uscarteams.org |
| Overview | <u>mx150 sealed connector system</u> |
| Product Name | MX150™ |

Physical

| | |
|-------------------------------|-----------------|
| Circuits (maximum) | 2 |
| Circuits Detail | 2 |
| Color - Resin | Gray |
| Gender | Female |
| Glow-Wire Compliant | No |
| Keying to Mating Part | Yes |
| Lock to Mating Part | Yes |
| Material - Resin | Nylon |
| Number of Rows | 1 |
| Packaging Type | Bag |
| Panel Mount | No |
| Pitch - Mating Interface (in) | 0.197 In |
| Pitch - Mating Interface (mm) | 5.00 mm |
| Pitch - Term. Interface (in) | 0.197 In |
| Pitch - Term. Interface (mm) | 5.00 mm |
| Polarized to Mating Part | Yes |
| Stackable | No |
| Temperature Range - Operating | -40°C to +125°C |

Electrical

| | |
|-------------------------------|-----|
| Current - Maximum per Contact | 15A |
|-------------------------------|-----|

Material Info

Reference - Drawing Numbers

| | |
|-------------------------|--------------|
| Packaging Specification | PK-30907-879 |
| Product Specification | PS-34062-000 |
| Sales Drawing | SD-34062-001 |



EU RoHS

ELV and RoHS Compliant
REACH SVHC
 Not Reviewed
Halogen-Free Status
 Not Reviewed

China RoHS



Need more information on product environmental compliance?

Email productcompliance@molex.com
 For a multiple part number RoHS Certificate of Compliance, [click here](#)

Please visit the [Contact Us](#) section for any non-product compliance questions.

Search Parts in this Series

34062Series

Mates With

Direct Connect only

Use With

34083 Tin (Sn) Cable Seal Female Terminal,
34081 Gold (Au) Cable Seal Female Terminal

| ASSEMBLY PART NUMBER | COLOR | KEYING OPTION | CPA | CLIPSLOT | TOOLED |
|----------------------|-------|---------------|-----|----------|--------|
| 34062-0001 | BLACK | A | NO | NO | YES |
| 34062-0002 | GRAY | B | NO | NO | YES |
| 34062-0003 | BLACK | C | NO | NO | YES |
| 34062-0004 | BLACK | D | NO | NO | YES |
| 34062-0005 | BLACK | A | YES | NO | YES |
| 34062-0006 | GRAY | B | YES | NO | YES |
| 34062-0007 | BLACK | C | YES | NO | YES |
| 34062-0008 | BLACK | D | YES | NO | YES |
| 34062-0009 | GRAY | D | NO | NO | YES |
| 34062-0010 | GRAY | D | YES | NO | YES |
| 34062-0011 | BLACK | A | NO | YES | YES |
| 34062-0012 | GRAY | B | NO | YES | NO |
| 34062-0013 | BLACK | C | NO | YES | NO |
| 34062-0014 | BLACK | D | NO | YES | NO |
| 34062-0015 | BLACK | A | YES | YES | YES |
| 34062-0016 | GRAY | B | YES | YES | NO |
| 34062-0017 | BLACK | C | YES | YES | NO |
| 34062-0018 | BLACK | D | YES | YES | NO |
| 34062-0019 | GRAY | D | NO | YES | NO |
| 34062-0020 | GRAY | D | YES | YES | NO |

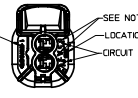
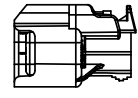
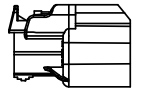
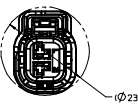
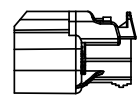
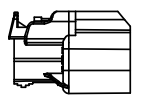
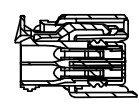
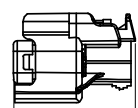
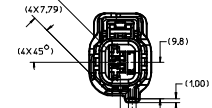
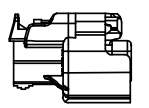
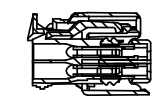
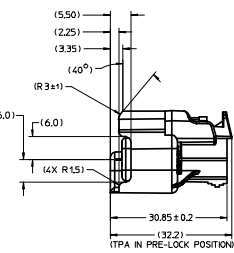
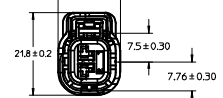
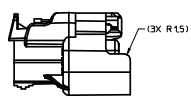
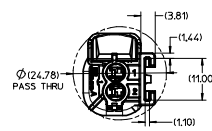
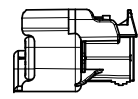
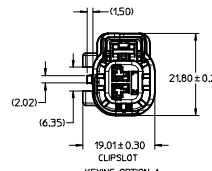
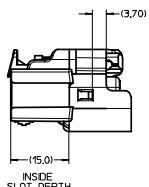
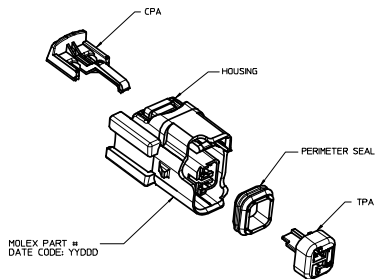
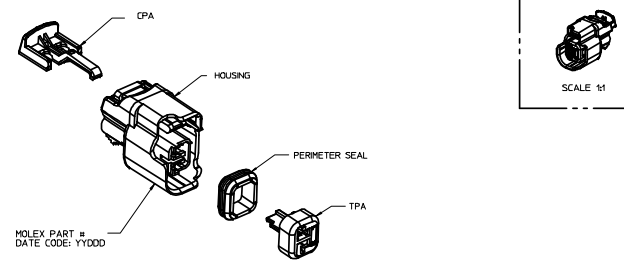
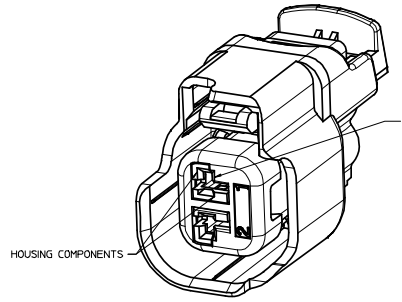
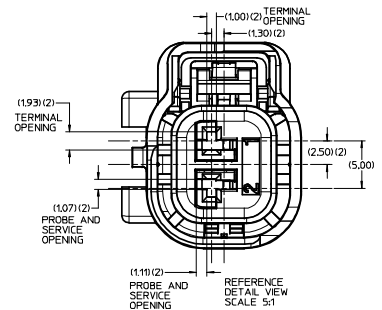

- NOTES: UNLESS OTHERWISE SPECIFIED
- ASSEMBLY CONFORMS TO:
SAE/USCAR-12, REV 2.
SAE/USCAR-2, REV 4.
EXCEPT TPA REMOVAL FROM FINAL LOCK - SECOND CYCLE.
SHALL NOT BE LESS THAN 12 NEWTONS
SAE/USCAR-20 DEC. 2001.
 - DESIGNED TO MATE WITH DEVICE CONNECTION AS SPECIFIED IN EWCAP DRAWING 550-5-002-1-201 REV A 19-18-2003.
 - ASSEMBLY SHIPPED WITH TPA IN PRE-LOCK POSITION (SEE SECTION B-B PRE-LOCK). UPON FULL TERMINAL ASSEMBLY, EACH TPA MUST BE SNAPPED INTO ITS FINAL-LOCK POSITION.
 - OPTIONAL CPA SHOWN IN ALL VIEWS. SEE TABLES FOR SPECIFIC ASSEMBLY OPTION AND NUMBER.
 - KEYING OPTION AND ASSEMBLY MACHINE IDENTIFIER.
 - RECYCLE CODE FOR PERIMETER SEAL: SILICON 50 DUROMETER
HOUSING: PPE/PA-GF30
TPA/CPA: PBT-GF30
 - SYSTEM TESTED USING ESB-HL123-A, 16/18, 20/22 AWG WIRE. MS-8288 AND MS9502 ARE ACCEPTABLE ALTERNATIVES.

| AWG | METRIC | PREFERRED TERMINAL | OPTIONAL TERMINAL | PAYOFF DIRECTION | PLATING | GRP | YAZAKI P/N | WIRE OD RANGE | COLOR | OSR P/N | WIRE OD RANGE | COLOR |
|-----|--------|--------------------|-------------------|------------------|---------|-------|--------------|---------------|-------|-----------|---------------|--------|
| 22 | 0.50 | 34083-2003 | 34083-0003 | RIGHT | TIN | 22 | 7158-3030-50 | 1.20-1.70 | RED | E-1644-01 | 1.19-1.65 | PINK |
| 22 | 0.50 | 34083-3003 | 34083-1003 | LEFT | TIN | 22 | 7158-3030-50 | 1.20-1.70 | RED | E-1644-01 | 1.19-1.65 | PINK |
| 22 | 0.50 | 34081-2005 | 34081-0005 | RIGHT | GOLD | 22 | 7158-3030-50 | 1.20-1.70 | RED | E-1644-01 | 1.19-1.65 | PINK |
| 22 | 0.50 | 34081-3005 | 34081-1005 | LEFT | GOLD | 22 | 7158-3030-50 | 1.20-1.70 | RED | E-1644-01 | 1.19-1.65 | PINK |
| 20 | 0.75 | 34083-2002 | 34083-0002 | RIGHT | TIN | 18/20 | 7158-3031-90 | 1.63-2.40 | BLUE | E-1644-00 | 1.60-2.10 | GREEN |
| 20 | 0.75 | 34083-3002 | 34083-1002 | LEFT | TIN | 18/20 | 7158-3031-90 | 1.63-2.40 | BLUE | E-1644-00 | 1.60-2.10 | GREEN |
| 20 | 0.75 | 34081-2004 | 34081-0004 | RIGHT | GOLD | 18/20 | 7158-3031-90 | 1.63-2.40 | BLUE | E-1644-00 | 1.60-2.10 | GREEN |
| 20 | 0.75 | 34081-3004 | 34081-1004 | LEFT | GOLD | 18/20 | 7158-3031-90 | 1.63-2.40 | BLUE | E-1644-00 | 1.60-2.10 | GREEN |
| 18 | 1.0 | 34083-2002 | 34083-0002 | RIGHT | TIN | 18/20 | 7158-3031-90 | 1.63-2.40 | BLUE | E-1644-00 | 1.60-2.10 | GREEN |
| 18 | 1.0 | 34083-3002 | 34083-1002 | LEFT | TIN | 18/20 | 7158-3031-90 | 1.63-2.40 | BLUE | E-1644-00 | 1.60-2.10 | GREEN |
| 18 | 1.0 | 34081-2004 | 34081-0004 | RIGHT | GOLD | 18/20 | 7158-3031-90 | 1.63-2.40 | BLUE | E-1644-00 | 1.60-2.10 | GREEN |
| 18 | 1.0 | 34081-3004 | 34081-1004 | LEFT | GOLD | 18/20 | 7158-3031-90 | 1.63-2.40 | BLUE | E-1644-00 | 1.60-2.10 | GREEN |
| 16 | 1.5 | 34083-2001 | 34083-0001 | RIGHT | TIN | 14/16 | 7158-3031-90 | 1.63-2.40 | BLUE | E-1644-02 | 2.10-2.50 | YELLOW |
| 16 | 1.5 | 34083-3001 | 34083-1001 | LEFT | TIN | 14/16 | 7158-3031-90 | 1.63-2.40 | BLUE | E-1644-02 | 2.10-2.50 | YELLOW |
| 16 | 1.5 | 34081-2003 | 34081-0003 | RIGHT | GOLD | 16 | 7158-3031-90 | 1.63-2.40 | BLUE | E-1644-02 | 2.10-2.50 | YELLOW |
| 16 | 1.5 | 34081-3003 | 34081-1003 | LEFT | GOLD | 16 | 7158-3031-90 | 1.63-2.40 | BLUE | E-1644-02 | 2.10-2.50 | YELLOW |

| | | | | | | |
|--|--------------------------------------|---|---|---|--|----------------------------|
| ENTER DESCRIPTION EC NO. UAU2008-063Z DRAWING/REV/DATE/APP/3-SHARE/REV/2003/04/08 | QUALITY SYMBOLS ▽-0 ▽-0 | GENERAL TOLERANCES (UNLESS SPECIFIED) mm INCH 4 PLACES ± --- ± --- 3 PLACES ± --- ± --- 2 PLACES ± 0.10 ± --- 1 PLACE ± 0.3 ± --- ANGULAR ± 3° | DIMENSION STYLE MM ONLY DRAWN BY DATE L.P.L.I.M 2002/11/15 CHECKED BY DATE DKOEHLER 2002/11/25 APPROVED BY DATE SPENDLET 2002/11/25 | SCALE 2:1 DESIGN UNITS METRIC THIRD ANGLE PROJECTION | TITLE CONNECTOR ASSEMBLY 2-WAY FUEL 15MM FEMALE FUEL INJECTOR CONNECTOR MATERIAL NO. TPA/CPA: PBT-GF30 DOCUMENT NO. MOLEX INCORPORATED | SHEET NO. 4 OF 4 |
| | | DRAFT WHERE APPLICABLE MUST REMAIN WITHIN DIMENSIONS | | SEE TABLE THIS DRAWING CONTAINS INFORMATION THAT IS PROPRIETARY TO MOLEX INCORPORATED AND SHOULD NOT BE USED WITHOUT WRITTEN PERMISSION | | SD-34062-001 |